

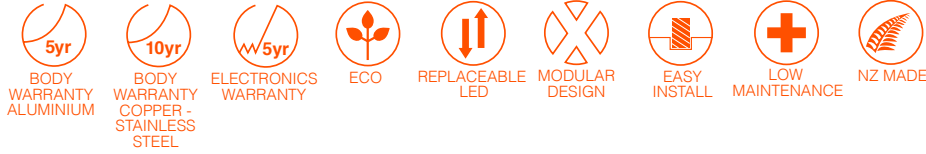

## M4 UPLIGHTER



### PRODUCT CONFIGURATION

Please fill in appropriate codes into boxes provided

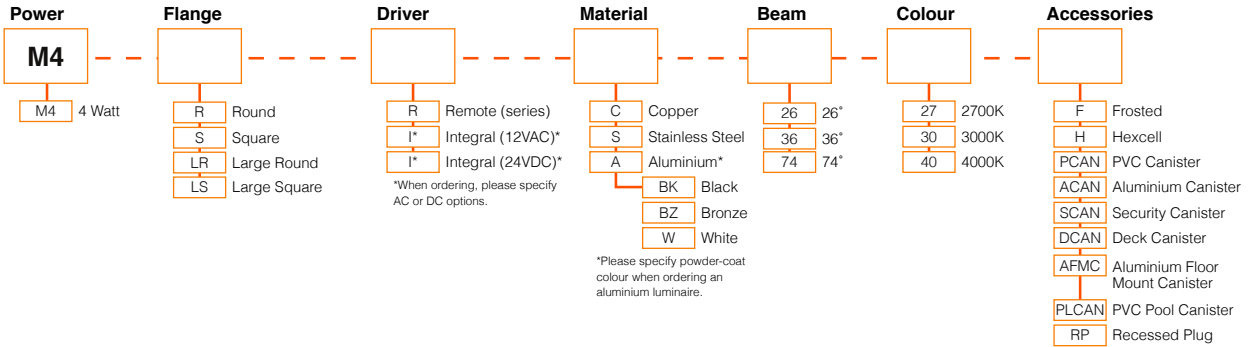

### SPECIFICATIONS

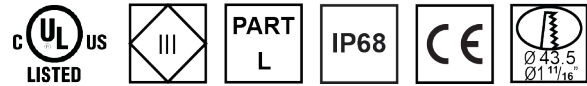

<b>Power</b>	4 Watt
<b>Ingress Protection Rating</b>	IP68
<b>Cable</b>	H05RN-F 2x 0.75mm (1m)
<b>Material</b>	- Black/ White/Bronze Powdercoated Aluminum - Natural Copper - 316 Stainless Steel
<b>Lens Options</b>	Clear or Frosted
<b>Hexcell Louvre</b>	Hexcell Louvre available
<b>Colour Temperature Options</b>	Warm White - 2700K and 3000K Neutral White - 4000k
<b>Removable Light Engine (LED)</b>	Screw Mounted 4W 6vf Cree™ XHP50 Chip
<b>Optic Degrees</b>	26°, 36°, 74°
<b>CRI</b>	90+ CRI
<b>Efficiency</b>	90lm/w - Delivered from Luminaire with unobstructed beam
<b>Input Options</b>	700mA Constant current (Remote) 12V AC (Integral) 24V DC (Integral)
<b>Warranty</b>	Electronics Warranty - 5 Years Aluminum Body - 5 Years Copper and Stainless Steel Body Warranty - 10 Years
<b>LED Shield</b>	LED Bypass Shunt LED Reverse Polarity Protection
<b>LED Life Expectancy</b>	50,000 Hours
<b>Load Rating</b>	Stainless Steel only 5000kg/11000lbs COPPER AND ALUMINIUM ARE SOFT METALS AND ARE NOT SUITABLE FOR DRIVE OVER APPLICATIONS

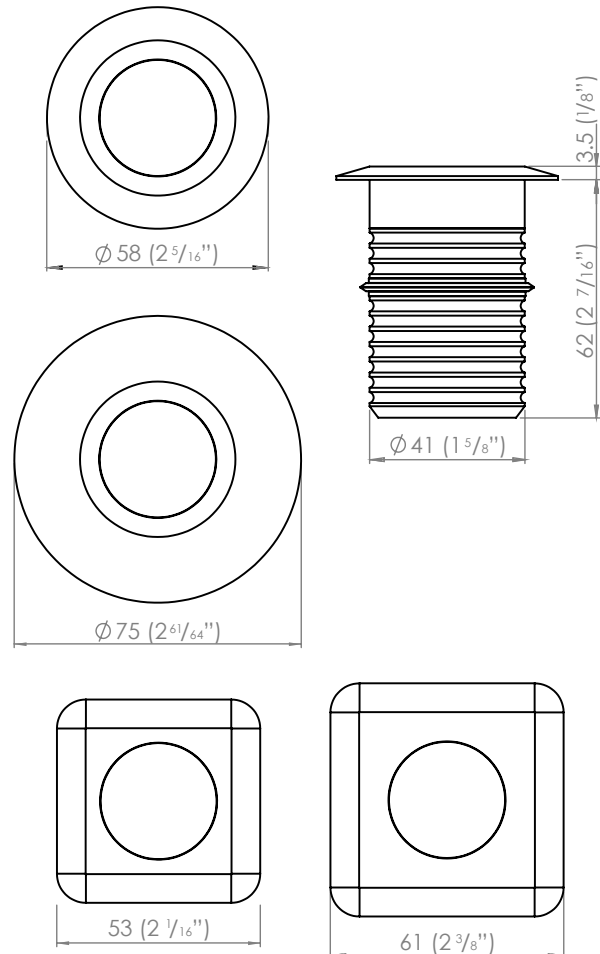



## BEAM ANGLES

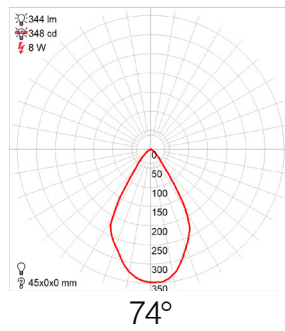
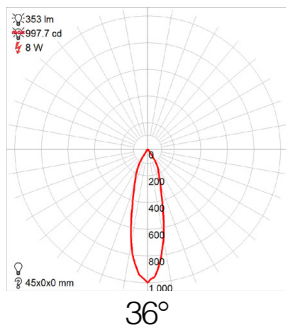
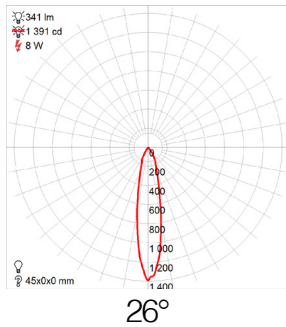

## REPLACING COMPONENTS

Firstly remove the luminaire from its recessed location.

Unscrew the flange paying close attention to the assembly order or refer to the diagram below. Locate the item that needs to be replaced, it is imperative you replace the component with factory LuxR parts to ensure correct operation of the luminaire.

When reassembling make sure all the components are in their correct order to ensure water tightness and correct light output.



## REMOTE DRIVER WIRED IN SERIES

Often referred to as series wiring the current in a series circuit follows one path from start-to-finish with the positive of the second LED connected to the negative of the first. Series wiring allows a single driver to be mounted remotely, powering a number of series fittings.

Often the most simplest of wiring schemes as each fitting is connected to the next in a daisy chain. It removes the need for a smaller 12 volt driver in each fitting.

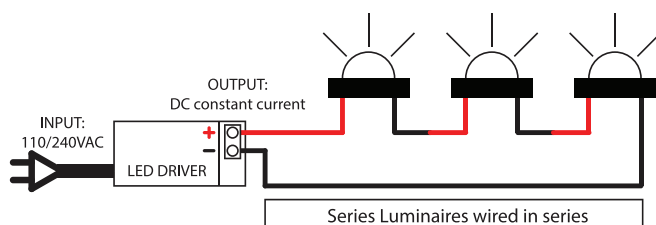

## ACCESSORIES

Recessed mounting canisters (Please refer to the canister spec sheets for more information).



## M4 RANGE

The M4 luminaire range is powered by a 4 watt LuxR light engine that offers a wide choice of LED colours. The luminaire was developed to meet the challenge of delivering high quality practical accent lighting with maximum energy efficiency and a long, maintenance-free life.

All LuxR luminaires offer a replaceable LED system using Cree LED chips for maximum performance and long life.

Precise LED binning by Cree ensure the same colour temperature across all our luminaires which allows LuxR products to be situated close to one another without the fear of colour variance in the colours.

This luminaire is extremely tough, durable and waterproof, making it ideal for installation in public spaces, large-scale projects and residential areas.

## RECOMMENDATIONS

Using the recessed mounting canisters will make recessed installation of this product simple. Core a hole in an existing wall or cast the canister in. Once in place, simply push the fitting into the canister. The luminaire will be retained by a silicon wiper seal.

## INTEGRAL DRIVER + TRANSFORMER

In a parallel circuit all the positive connections are tied together and back to the positive output of the LED driver and all the negative connections are tied together and back to the negative output of the driver.

The integral driver option allows LuxR fittings to be wired in parallel to existing or new installations where a wire wound or magnetic transformer is being used.

