

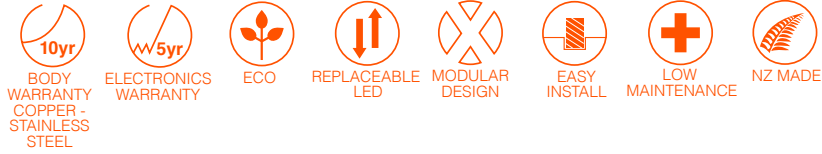

M4 RGBW REMOTE 8-CORE



PRODUCT CONFIGURATION

Please fill in appropriate codes into boxes provided

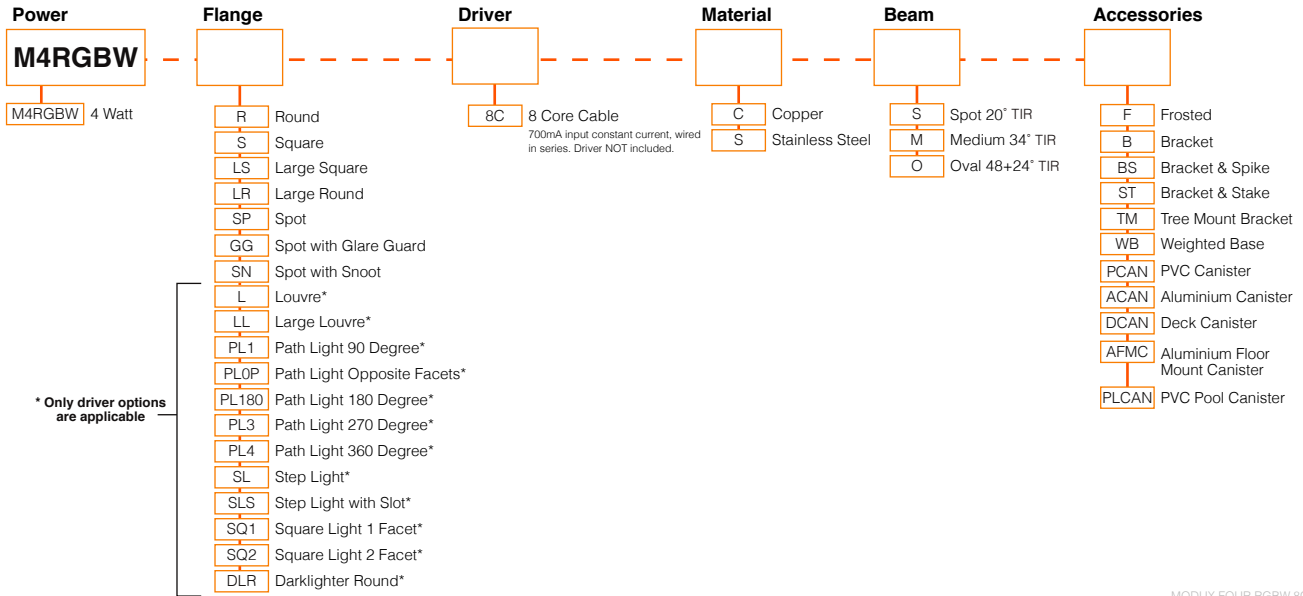

MODUX FOUR RGBW 8C

SPECIFICATIONS



Input	700MA - 4 Circuit
Power Consumption	4.5W per luminaire maximum (all 4 colours at 100%)
Light Engine	Plug-In dimmable module equipped with a high power Cree 4x1 watt RGBW LED
Cabling	Special 8 Core UV stabilized and Waterproof cable.
Standards	IP68, LM79, CE, UL
Efficacy	220lm all colours on - Delivered from Luminaire with unobstructed beam
Beam (FWHM)	Spot (20°), Medium (34°) and Oval (48°+24°)
Cable Length	3 meters (10ft) Standard - (Custom lengths can be specified at an additional charge)
Lens Cover	Clear glass, frosted glass
Colours	Neutral White 4000°k, Red, Green and Blue
Max Run Length	Cabling between the controller and the last luminaire must not exceed 200m.
Addressability	Please note that fixtures are not individually addressable, the circuit will have the address of the driver for scene controllable.
Warranty	Electronics Warranty 5 Years
Body Warranty	10 years for Stainless Steel and Copper

M4 RGBW

There are a number of features that make the LuxR solution unique:

- The DMX 'dimmer' driver is integrated into the luminaire itself.
- There is only one cable required per luminaire, therefore the cable entry can be sealed with the proven LuxR anti-siphon pot and is replaceable.
- The RGBW LED is a compact single die unit and is easily replaceable.
- The specialised optics superimpose each red, green, blue and white flux radiation directly over the top of each other so that no LED offset effects are created.

The luminaire was developed to meet the challenge of delivering high quality practical accent lighting with maximum energy efficiency and a long, maintenance-free life. All LuxR luminaires offer a replaceable LED system using Cree LED chips for maximum performance and long life.

This luminaire is extremely tough, durable and waterproof, making it ideal for installation in public spaces, large-scale projects and residential areas.

CONSIDERATIONS

Luminaires (per POWER circuit)	Up to 14 per EldoLED POWERdrive 106/S
Luminaires (per DATA circuit without repeaters)	Unlimited
Power (per luminaire)	4.3W
DMX Compatible	✓
DALI Compatible	✓
Wiring	Series Wired
Circuit Length*	Long
Cost Effective*	Medium to large projects
DMX addressing	"On-site" push buttons on the driver
Scene Setting	Dynamic Scenes via DMX or DALI Controller
Required Components	1x EldoLED POWERdrive 106/S Constant Current LED Driver per circuit (not supplied) 1x DMX512 or DALI Controller (not supplied) <small>(to provide DMX or DALI signal for instruction to the POWERdrive 106/S)</small>
Additional Considerations*	Cost Effective Best suited for long circuits Requires waterproof driver enclosure
Defaults settings if NO DMX connected	Choose from multiple colour scroll scenes from the POWERdrive presets. Adjust colour output (intensity, hue, white)

*Indicative only, please consult a LuxR Outdoor Lighting Specialist for additional support.

POWER CHARACTERISTICS

- 1 Watt maximum per LED colour emitter
- Maximum power draw per luminaire (R,G,B+W at 100%) including driver losses = 4.5W per luminaire
- Input power must be: 350mA.

Colour		CCT/ Dominant Wavelength Range		Minimum Luminous Flux @350mA
		Min.	Max.	Flux (lm)
Colour+ Neutral White	Red	620 nm	630 nm	45.7
	Green	520 nm	535 nm	87.4
	Blue	450 nm	465 nm	13.9
	Neutral White	3700 K	4300 K	80



DRIVER

EldoLED POWERdrive 106/S: This format is the most simple and cost effective solution for large simple scene installations. The luminaires will respond in unison per individual series wired driver

Cabling must be installed with IP rated connection methods that seal all layers of insulation.

The DMX addresses can be set at the driver. Preset scenes accessible from a push button menu structure or via DMX or DALI. It has a 110-240V driver. **NEEDS TO BE STORED IN A DRY LOCATION.**

Tunable dynamic response: Dynamic response can be tuned to fit any content - from exceptionally smooth fades in architecture to fast-paced video in entertainment.

HydraDrive: provides the smoothest colour fades and dimming to dark.

INSTALLATION

Recommended Installation: Output wired in series, apply DMX or DALI controller to the POWERdrive to create a dynamic range of scenes.

NO DMX Installation: Choose from multiple colour scroll scene from POWERdrive presets. Adjust colour output (intensity, hue, white) all within the push button menu.

WIRING DIAGRAM

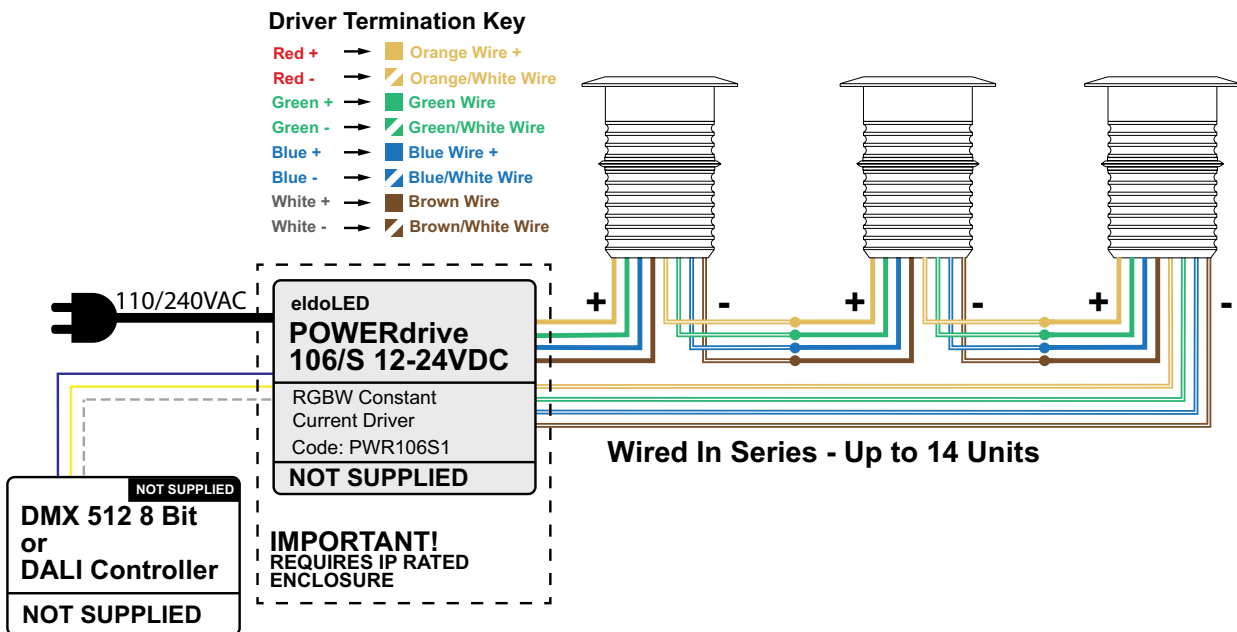

REPLACING COMPONENTS

Firstly remove the luminaire from its recessed location.

Unscrew the flange paying close attention to the assembly order or refer to the diagram below. Locate the item that needs to be replaced, it is imperative you replace the component with factory LuxR parts to ensure correct operation of the luminaire.

When reassembling make sure all the components are in their correct order to ensure water tightness and correct light output.

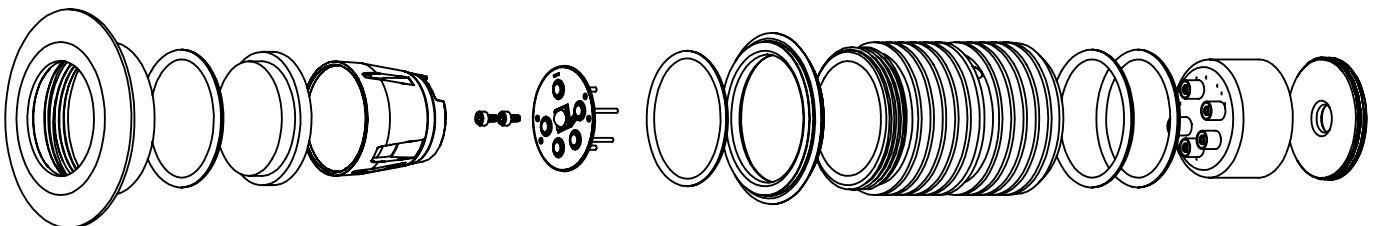

The special highly rated LuxR Hybrid Cable
8 x 0.5mm² power cores.



M4 RGBW UPLIGHTER DIMENSIONS

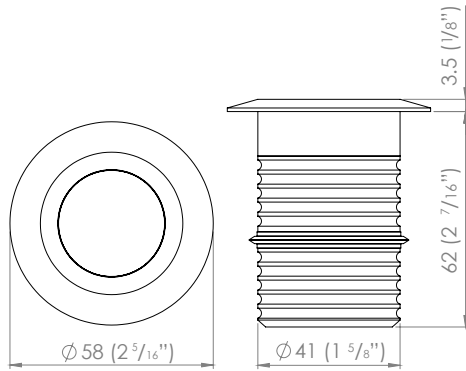

ROUND (R)

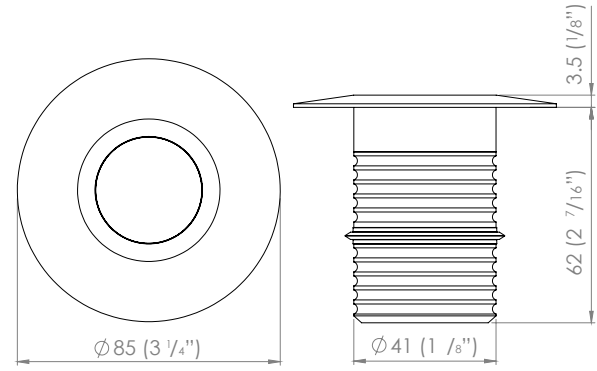

LARGE ROUND (LR)

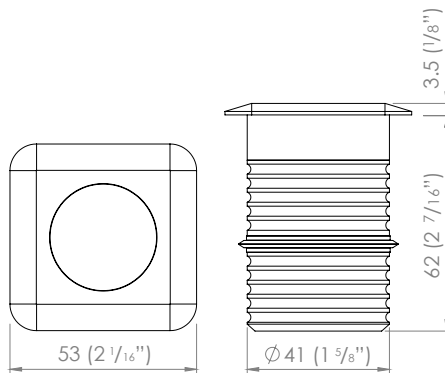

SQUARE (S)

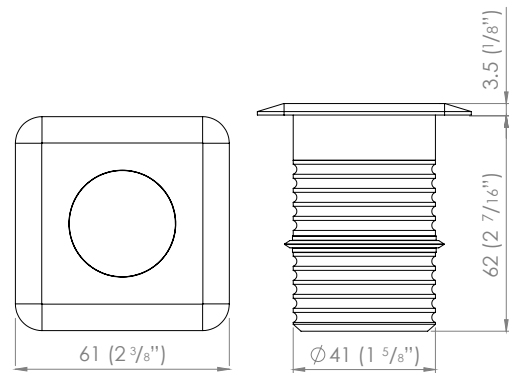

LARGE SQUARE (LS)

M4 RGBW LOUVRE DIMENSIONS

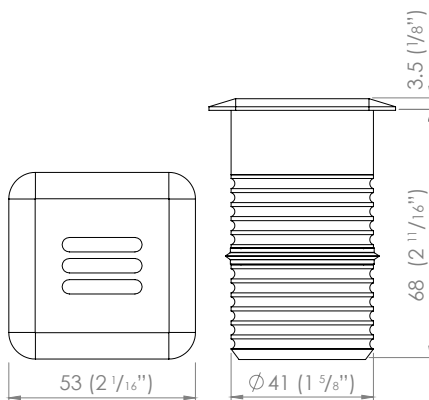

LOUVRE (L)

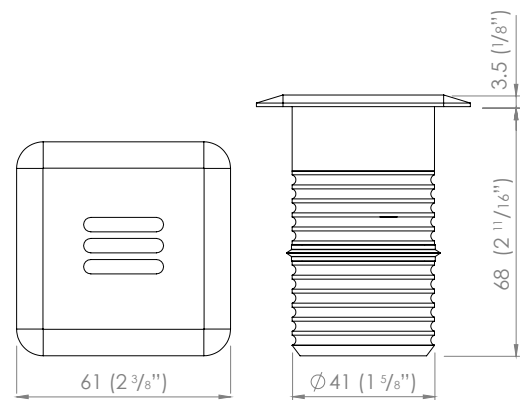

LARGE LOUVRE (LL)

RECOMMENDATIONS

Using the recessed mounting canisters will make recessed installation of this product simple. Core a hole in an existing wall or cast the canister in. Once in place, simply push the fitting into the canister. The luminaire will be retained by a silicon wiper seal.



M4 RGBW STEPLIGHT DIMENSIONS

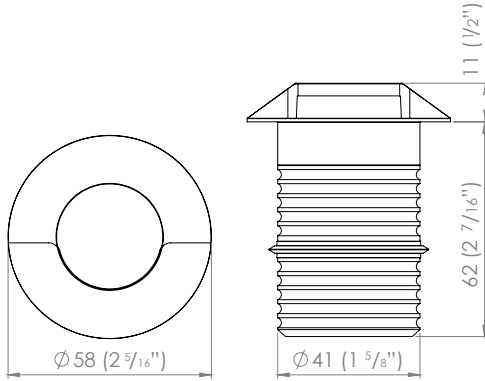

STEP LIGHT (SL)

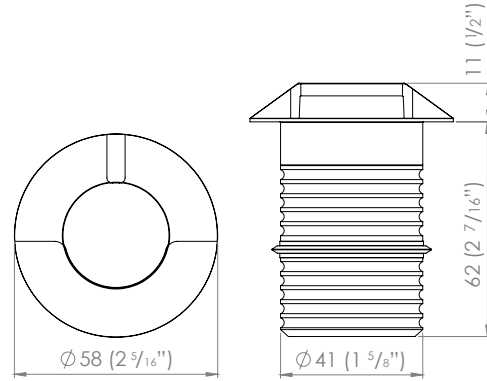

STEP LIGHT WITH SLOT (SLS)

M4 RGBW PATHLIGHT DIMENSIONS

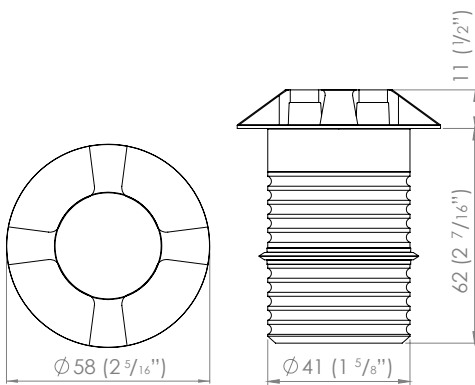

PATH LIGHT (PL)

FLANGE OPTIONS:

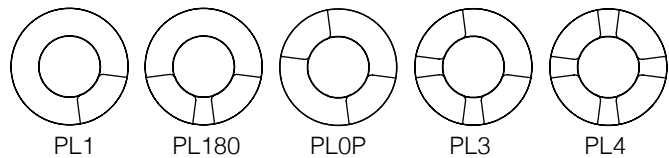

M4 RGBW SQUARELIGHT DIMENSIONS

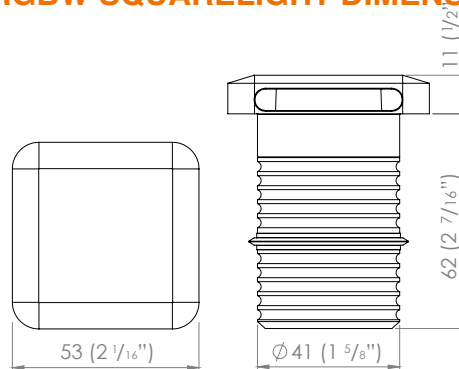

SQUARE LIGHT 1 FACET (SQ1)
SQUARE LIGHT 2 FACET (SQ2)

RECOMMENDATIONS

Using the recessed mounting canisters will make recessed installation of this product simple. Core a hole in an existing wall or cast the canister in. Once in place, simply push the fitting into the canister. The luminaire will be retained by a silicon wiper seal.



M4 RGBW SPOT LIGHT DIMENSIONS

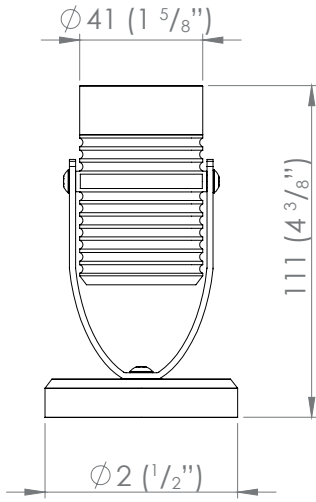

WITH WEIGHTED BASS ACCESSORY (WB)

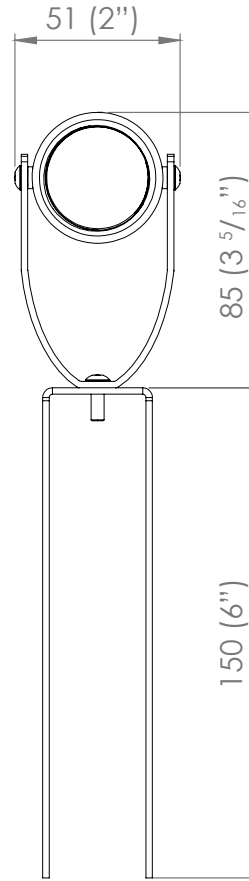
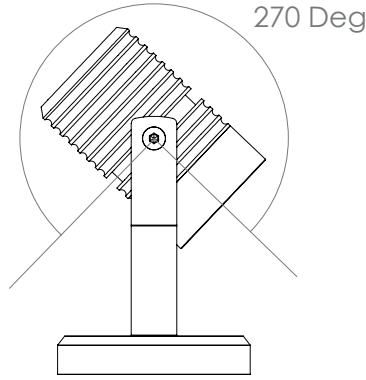

SPOT WITH BRACKET & STAKE ACCESSORY (ST)

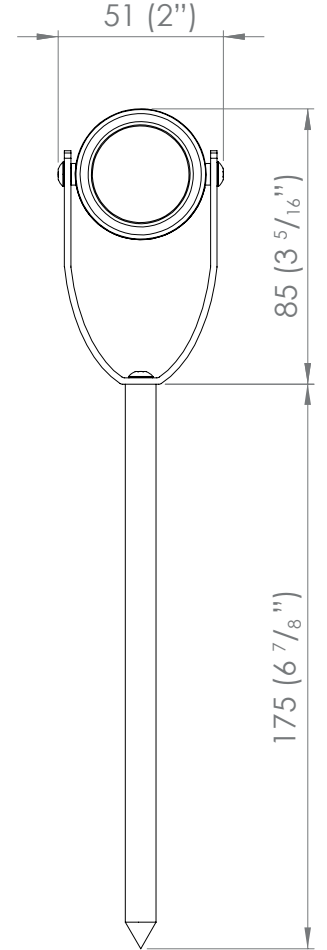

SPOT WITH BRACKET & SPIKE ACCESSORY (BS)

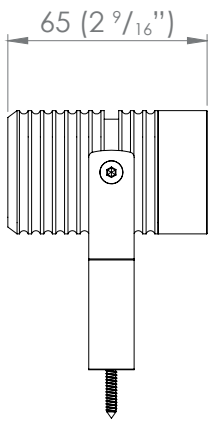

WITH BRACKET ACCESSORY (B)

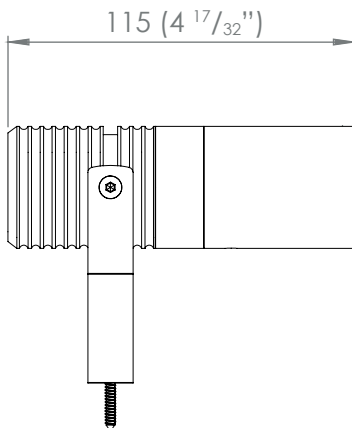
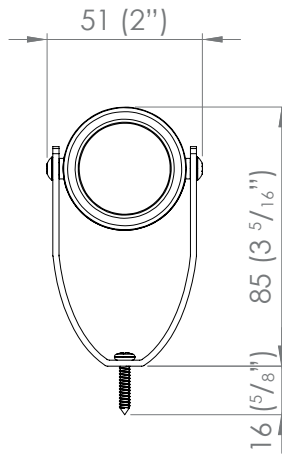

SPOT WITH SNOOT (SN)

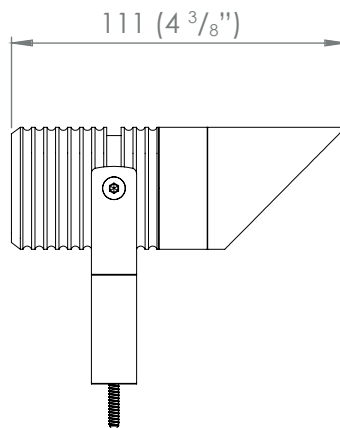

SPOT WITH GLARE GUARD (GG)