



M1 UPLIGHTERS CONFIGURATION

M1	Power 1 Watt	Flange round square	Driver remote (series) integral (12V AC) #	Material copper s/steel aluminium	Beam 15° TIR 30° TIR 53° TIR 50+17° 50+17° Oval° TIR	Colour 2700K 3000K 4000K 5000K	Accessories frosted pvc canister aluminium canister recessed plug
M1	R S	R I	C S A	BK black BZ bronze W white	27 30 40 50	R G B A	F PCAN ACAN RP

Available in anti-siphon only

Please specify powdercoat colour when ordering an aluminium luminaire

SPECIFICATIONS

Power	1 Watt
Ingress Protection Rating	IP68
Cable	H05RN-F 1m Included
Material	- Black/White/Bronze Powdercoated - Natural Copper - 316 Stainless Steel
Removable Light Engine	Pin Mounted 1W Cree XPG-3 Chip
Colour Temperature	Warm White - 2700K and 3000K Neutral White - 4000k Cool White - 5000k Red, Green, Blue, Amber
Optic Degrees	15°TIR, 30°TIR, 53°TIR, 50+17°TIR
Lens Cover	Clear and Frosted
CRI	90+ CRI
Efficiency	80lm/w - Delivered from Luminaire with unobstructed beam
Input	350mA Constant current (Remote) 12V AC (Integral)
Warrenty	Electronics Warrantly 5 Years
Body Warrenty	5 years Aluminium and 10 years Copper and Stainless Steel
LED Shield	LED Bypass Shunt Reverse polarity protection
Load Rating	Stainless Steel 4000kg/8800lbs Copper 4000kg/8800lbs Aluminium 3500kg/7700lbs

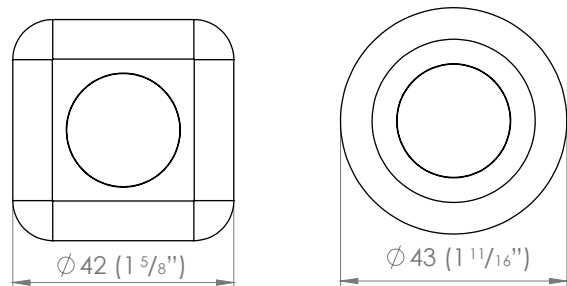
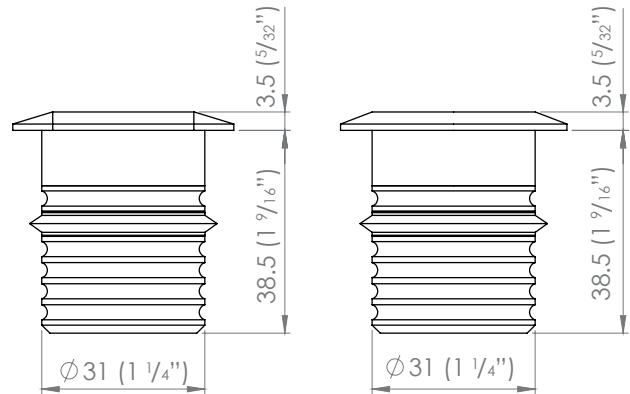
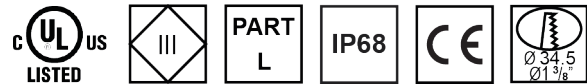

INTEGRAL (12VAC) DRIVER HOUSING

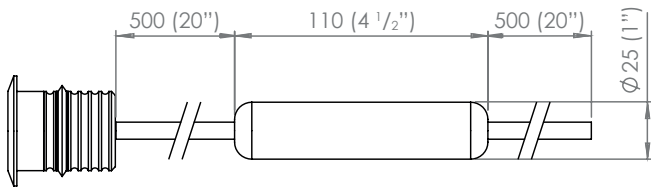

M1 UPLIGHTERS

The M1 luminaire range is powered by a 1 watt LuxR light engine that offers a wide choice of LED colours. The luminaire was developed to meet the challenge of delivering high quality practical accent lighting with maximum energy efficiency and a long, maintenance-free life.

All LuxR luminaires offer a replaceable LED system using Cree LED chips for maximum performance and long life. Precise LED binning by Cree ensure the same colour temperature across all our luminaires which allows LuxR products to be situated close to one another without the fear of colour variance in the colours.

This luminaire is extremely tough, durable and waterproof, making it ideal for installation in public spaces, large-scale projects and residential areas.

REPLACING COMPONENTS

Firstly remove the luminaire from its recessed location. Unscrew the flange paying close attention to the assembly order or refer to the diagram below. Locate the item that needs to be replaced, it is imperative you replace the component with factory LuxR parts to ensure correct operation of the luminaire. When reassembling make sure all the components are in their correct order to ensure watertightness and correct light output.

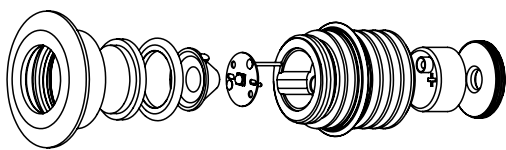

REMOTE DRIVER WIRED IN SERIES

Often referred to as series wiring the current in a series circuit follows one path from start-to-finish with the positive of the second LED connected to the negative of the first. Series wiring allows a single driver to be mounted remotely, powering a number of series fittings. Often the most simplest of wiring schemes as each fitting is connected to the next in a daisy chain. It removes the need for a smaller 12 volt driver in each fitting.

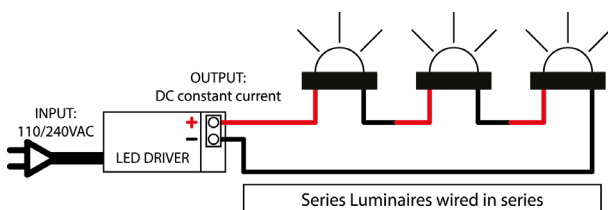

BEAM ANGLES

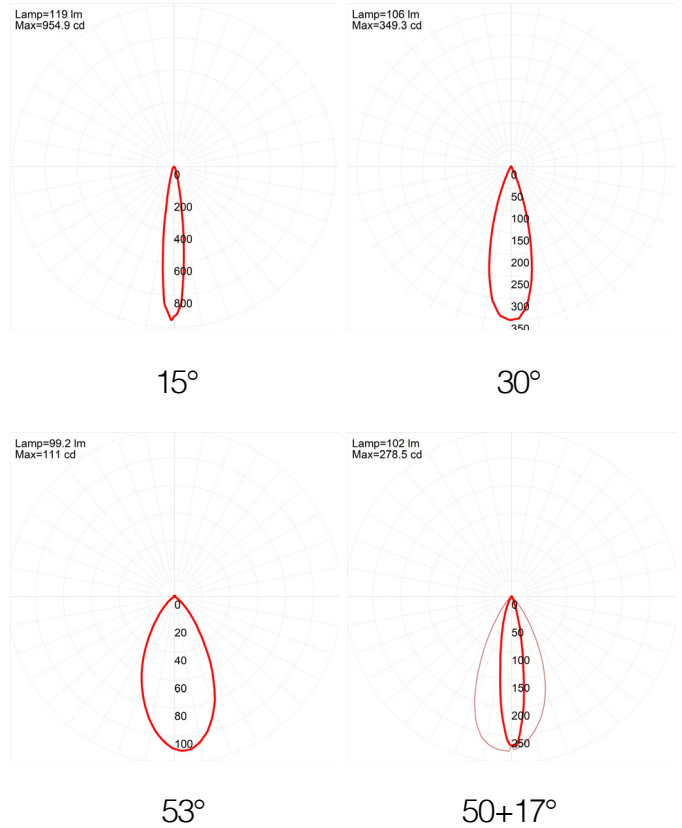

ACCESSORIES

PVC recessed canister - Aluminium recessed canister (Please refer to the canister spec sheets)

RECOMMENDATIONS

Using the PVC or aluminium mounting canister will make recessed installation of this product simple. Core a hole in an existing wall or cast the canister in. Once in place, simply push the fitting into the conduit hole. The luminaire will be retained by a silicon wiper seal.

INTEGRAL DRIVER + TRANSFORMER

In a parallel circuit all the positive connections are tied together and back to the positive output of the LED driver and all the negative connections are tied together and back to the negative output of the driver. The integral driver option allows LuxR fittings to be wired in parallel to existing or new installations where a wire wound or magnetic transformer is being used.

